



RxE 10k Rotating Electrode™

QUICK-START GUIDE



Unpacking

1

1. Verify that you have received all parts listed on your packing list and that no part is damaged.



If anything is missing or parts are damaged, contact Gamry's support (<https://www.gamry.com/support-2/>) or your local distributor. Do not use any damaged part as they impose a safety hazard.

Hardware setup

Connect USB cable

2.1

1. Place rotator and Motor Controller on a flat workbench surface. Leave enough space to the rear side to have access for the cables.
2. Connect the Motor Controller to a computer using the high-speed USB A/B cable provided with your system (P/N 985-00131).
3. Connect the type A end (the wider, rectangular shaped connector) into a USB port on your computer or USB hub).
4. Connect the type B end (a nearly square connector plug) into the **USB** port on the rear panel of the Motor Controller.
5. The USB connection can be "hot plugged". This means both the computer and the Motor Controller can be powered up before the USB cable is plugged in.

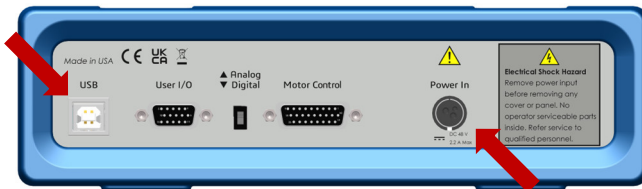

2.2

Connect Power In cable

1. The Motor Controller does not plug in directly into the AC mains supply but uses an external power supply which supplies a regulated 48 V DC output.
2. The external power supply is normally supplied with a line cord suitable for use in your country.
3. The DC output cord from the external power supply plugs into the DC **Power In** jack on the rear panel of the Motor Controller



When replacing the line cord for the power supply, always verify that it has adequate power ratings. Do **not** use a line cord that shows any damages or exposed wires.

2.3

Connect the Motor Control cable

1. The RxE 10k rotator does not directly plug into the AC mains supply. Instead, it is powered and controlled by the Motor Controller using the Motor Control Cable (P/N 985-00194).
2. The Motor Control Cable has three dedicated power lines for the motor and two additional power lines for the encoder and fan.
3. Connect the female 26-pin HD D-sub connector of the cable to the **Motor Control** connector on the rotator's rear panel.
4. Connect the male 26-pin HD D-sub connector of the cable to the **Motor Control** connector on the Motor Controller's rear panel.

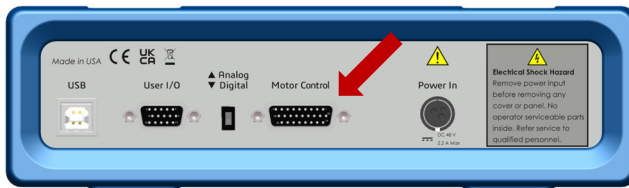

2.4

Power up instrument

1. Power up your system by pressing the **Power** button on the Motor Controller front panel. The blue **Power LED** blinks until steady. The **USB LED** turns green if a valid connection has been made to the computer.
2. The LC-display turns on showing the rotator's model number and subsequently the rotation speed display.

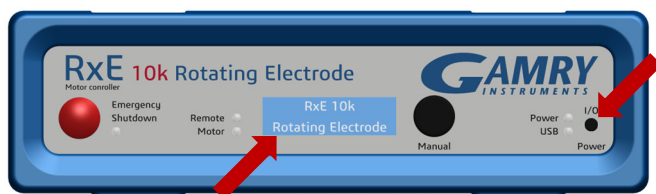

2.5

Rotator test

1. Perform a quick start-up test to check the rotator's functionality.



Install the Safety Shield and always wear safety goggles while operating the RxE 10k system. While extremely rare, rotating shaft, electrode, or attached parts can break and fly off, injuring the operator.

2. Turn the **Manual** knob clockwise until the speed on the LC display reads 100 rpm. Press the knob to confirm the setting. The motor should turn on and the motor shaft begin accelerating to the set rotation speed.

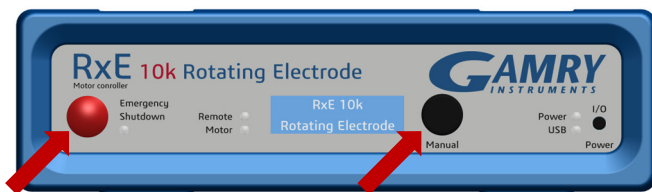

3. During operation, the **Motor LED** is turned on. Increase and decrease the rotation speed by rotating the knob clockwise or counterclockwise, respectively. Verify that the rotator operates smoothly.

4. Press the **Emergency Shutdown** button to the left. The motor should abruptly turn off and the motor shaft stop rotating. System control is now fully disabled. The LC display shows a warning message.



SHUTDOWN - Cycle
Power to Reset

5. To re-enable the rotary system, press the **Power** switch.

2.6

Potentiostat setup

1. Depending on the electrode, either a single potentiostat is required for RDE and RCE experiments or a bi-pstat setup for RRDE experiments.



Follow the installation instructions of the potentiostat. A current version of each manual can be downloaded on Gamry's website at <https://www.gamry.com/support/documentation-downloads/>.

2.7

Connect cell cables

1. The cell cable connectors (4 mm female banana) are located on the rear side of the RxE 10k rotator.
 - The **Disk/RCE** connectors connect to the disk of an RDE/RRDE and cylinder electrode of an RCE.
 - The **Ring** connectors connect to the ring electrode of an RRDE.



RDE/RCE setup

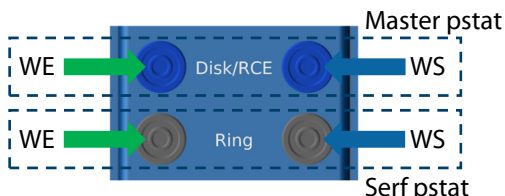

RRDE setup

Mounting electrode shaft and electrode

3



Before replacing any parts on the rotator, make sure that the instrument is turned **OFF**. Rotating components are a safety hazard. Complying with all necessary protection measures is crucial for your personal safety.

Remove front cover

3.1

1. Slightly unscrew the six thumb screws on the left and right side of the rotator enclosure. Carefully slide off the rotator enclosure.
2. The interior reveals four carbon brushes. They are protected by red covers. Leave them on for now until the electrode shaft is installed.
3. Additionally, four wires go from each PCB to the rotator's back panel and banana connectors. You can leave them as they are.

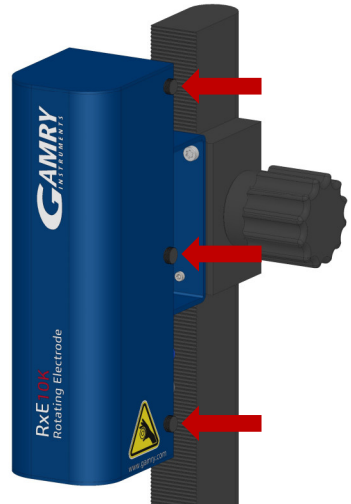

Unscrew brush holders

3.2

Unscrew the thumb screws on both sides that hold the brush holders in place. Rotate them outwards.

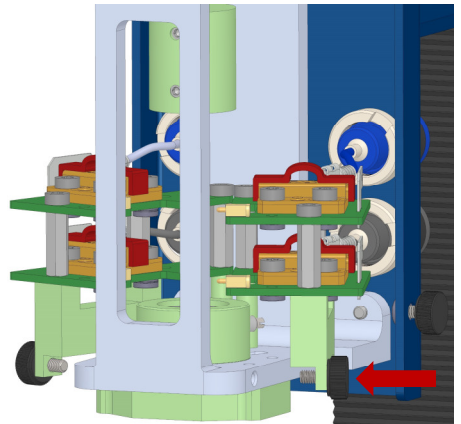

3.3

Prepare shaft adapter

Above the brush holders, you can see the shaft adapter mounted onto the motor shaft. Unscrew the bottom two set screws which will be later used to attach the electrode shaft.

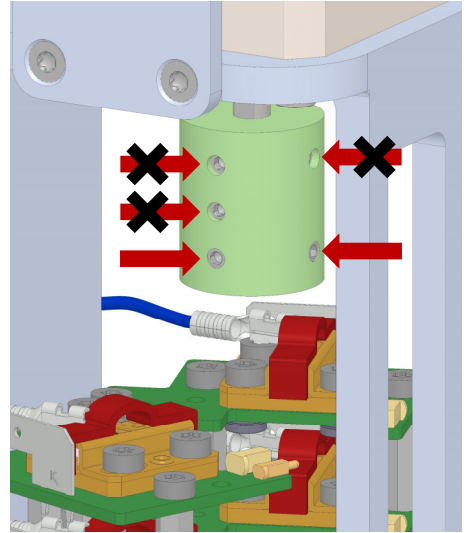

Do **not** open the top set screws attaching the shaft adapter to the motor's shaft. Do **not** remove the center set screw. It electrically separates motor shaft and electrode shaft.

3.4

Install electrode shaft

1. Carefully guide the electrode shaft from the bottom of the rotator through the bearing housing.



Do **not** bend shaft sideways, tilt, or force it through the bearings. This can irreversibly damage both bearings and shaft.

2. Slide the electrode shaft upwards into the shaft adapter until it touches the center set screw.
3. Secure the electrode shaft by tightening both set screws. Do **not** overtighten the screws!

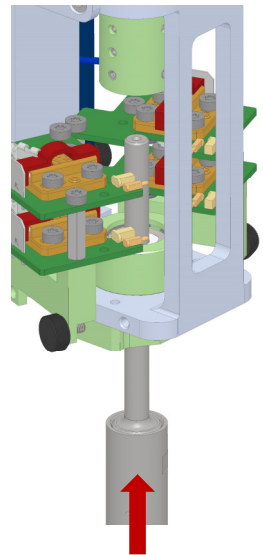

3.5

Test the electrode shaft

1. Carefully remove all four red covers from the brushes. The brushes snap outwards.
2. Move both brush holders back to their original position and secure them again with the previously removed thumb screws.
3. Test the assembly by manually rotating the shaft. The electrode shaft should rotate freely without much counterforce. Make sure that all four brushes have good contact with the electrode shaft.
4. After verifying correct functionality, put the rotator enclosure back on and secure with the six thumb screws.

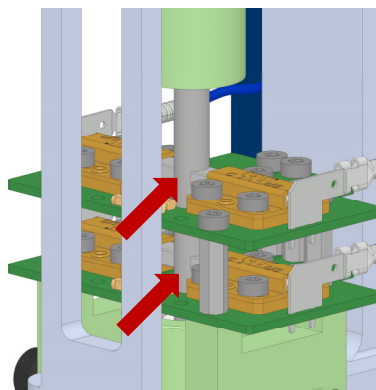

Upper and lower brushes are electrically insulated from each other. When using an RRDE shaft, verify that both upper brushes make contact above the RRDE shaft's PEEK insulator. The lower brushes should make contact below the shaft's PEEK insulator.

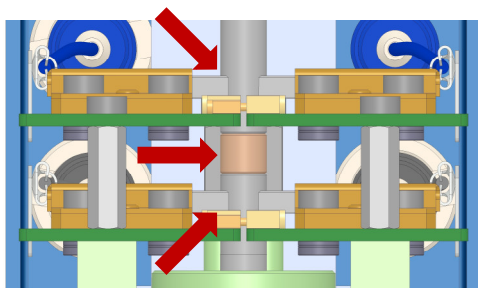

3.6

Mount electrode

Hold the lower part of the electrode shaft in place. Guide the electrode into the shaft's sleeve and screw on hand tight. Do **not** bend the shaft sideways, otherwise the bearings, shaft, and carbon brushes could get damaged.



Make sure to have an RRDE shaft installed when using RRDEs. The RRDE shaft has two electrically insulated portions for the disk and the ring electrode. RDEs and RCEs should be preferably used with the RDE/RCE shaft.



The RCE cylinders have an oil coating to prevent rust during storage. It is recommended to rinse them with an organic solvent such as methanol, ethanol, or isopropyl alcohol before usage.

Safety Shield installation

4



Even with the Safety Shield installed, always wear safety goggles while operating the RxE 10k system. While extremely rare, rotating shaft, electrode, or attached parts can break and fly off, injuring the operator.

Use extra caution when running experiments with glass cells.

4.1

Prepare rotator base plate

Slightly unscrew all eight knurled knobs at the front and back of the rotator base plate. Don't unscrew completely as the Safety Shield will rest on top of the threads.

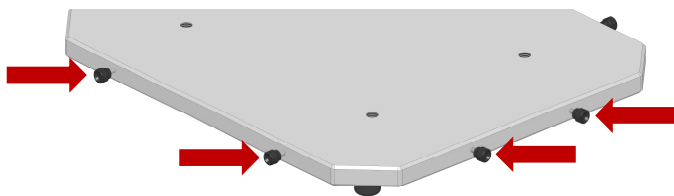

4.2

Mount Safety Shield

1. Unfold a Safety Shield and align the slots on the bottom side of the acrylic panels with the exposed threads of the knobs.

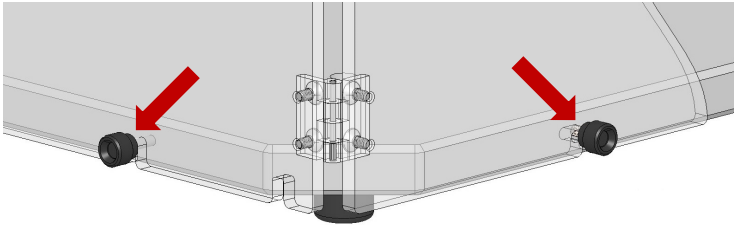

2. Push the Safety Shield fully back towards the base plate to lock the side threads within the panels' L-slots.

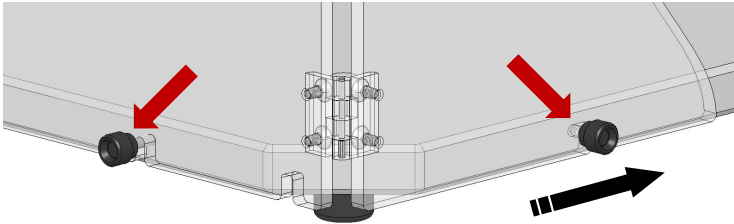

3. Tighten all four knobs to secure the Safety Shield.
4. Repeat these steps for the second Safety Shield.

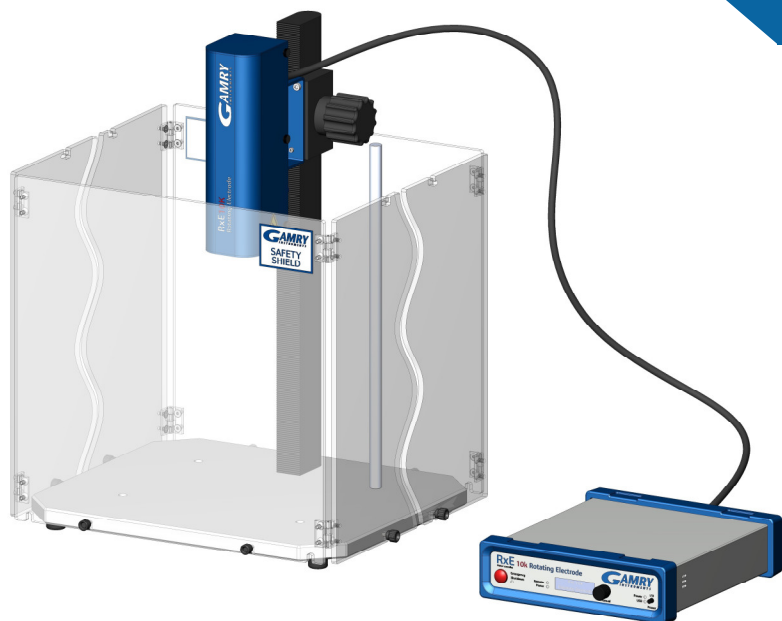

Software configuration using GIM

5

1. Power up both Motor Controller and potentiostat.
2. Launch the Gamry Framework™ software and open the Gamry Instrument Manager (GIM) under **Option/Instrument Manager...**

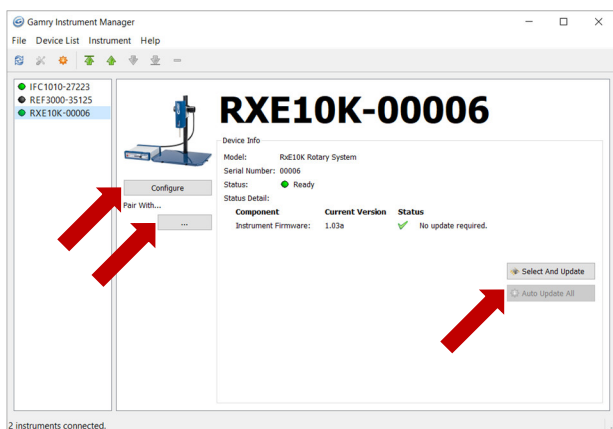

3. Press the **Configure** button to set the maximum permitted rotation speed. The maximum value is 10500 rpm.

4. Click the ... button under **Pair with...** to select a potentiostat to pair with your rotator. Once confirmed, the selected potentiostat is listed as paired device in the Gamry Instrument Manager.
5. Instrument information and installed firmware software are listed under **Device Info**. A warning symbol appears if software and firmware are not compatible. To update the firmware, press the **Auto Update All** button or **Select And Update** to manually select the firmware.



Do not power off or disconnect the instrument during this process. Doing so can cause irreversible damage to the instrument.

Running experiments within Framework

6

1. Launch the Gamry Framework™ software and open the Gamry Sequence Wizard under **Experiment > Sequence Wizard**
2. Create a custom experiment sequence. Select from a list of individual experiments and utilities and simply drag-and-drop them to your user-defined sequence.

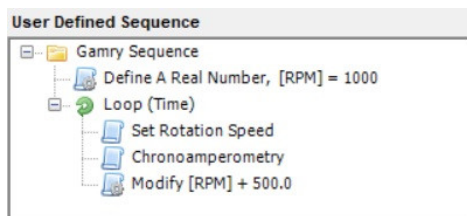

Please visit Gamry's service and support page if you require additional assistance. The QR-code on the right provides a direct link to the RxE 10k website and its latest documentation.



Contact your local Gamry representative or Gamry's technical support if you experience any problems.

Phone: +1 215-682-9330

Web: <https://www.gamry.com/support-2/>

Email: techsupport@gamry.com